

BOTTOM VIEW

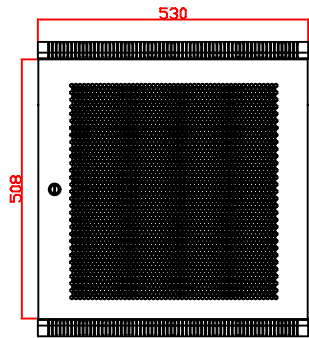

FRONT VIEW

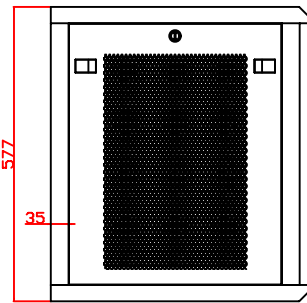

SIDE VIEW

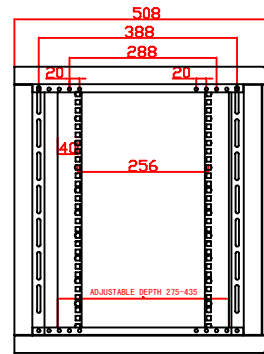

SIDEVIEW WITH PANEL REMOVED

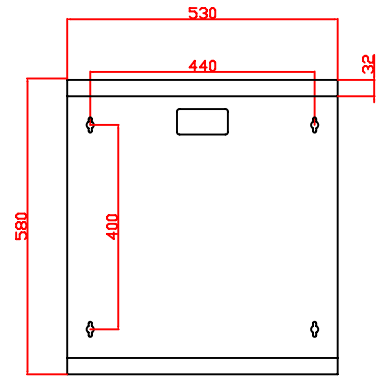

BACK VIEW

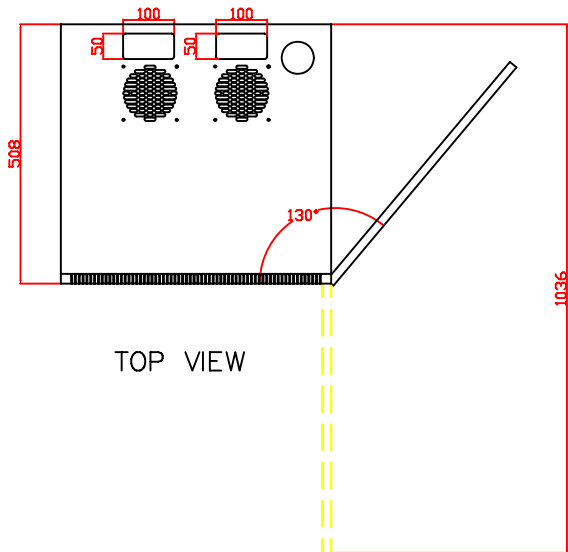

TOP VIEW



QUEST MANUFACTURING CO.

11200 NW 138 St., Medley, FL 33178

TEL: 305-513-8583 FAX: 305-513-9675

WWW.QuestManufacturing.net

ITEM NO.

WM2119-11-02

Drawn By

Date

Material

C.R.S.

Checked By

Date

Unit

mm

Approved By

Date

Surface Finish

Power Coat

Scale

1:1

